

**Major Ratings and Characteristics**

Characteristics	400CMQ...	Units
$I_{F(AV)}$ Rectangular waveform	400	A
$V_{RRM}$ range	35 to 45	V
$I_{FSM}$ @ $t_p = 5 \mu s$ sine	29,000	A
$V_F$ @ 200Apk, $T_J = 125^\circ C$ (per leg)	0.52	V
$T_J$ range	-55 to 150	$^\circ C$

**Description/Features**

The 400CMQ high current Schottky rectifier module series has been optimized for very low forward voltage drop, with moderate leakage. The proprietary barrier technology allows for reliable operation up to 150 °C junction temperature. Typical applications are in switching power supplies, converters, free-wheeling diodes, welding, and reverse battery protection.

- 150 °C  $T_J$  operation
- Center tap module - Isolated Base
- High purity, high temperature epoxy encapsulation for enhanced mechanical strength and moisture resistance
- Very low forward voltage drop
- High frequency operation
- Guard ring for enhanced ruggedness and long term reliability

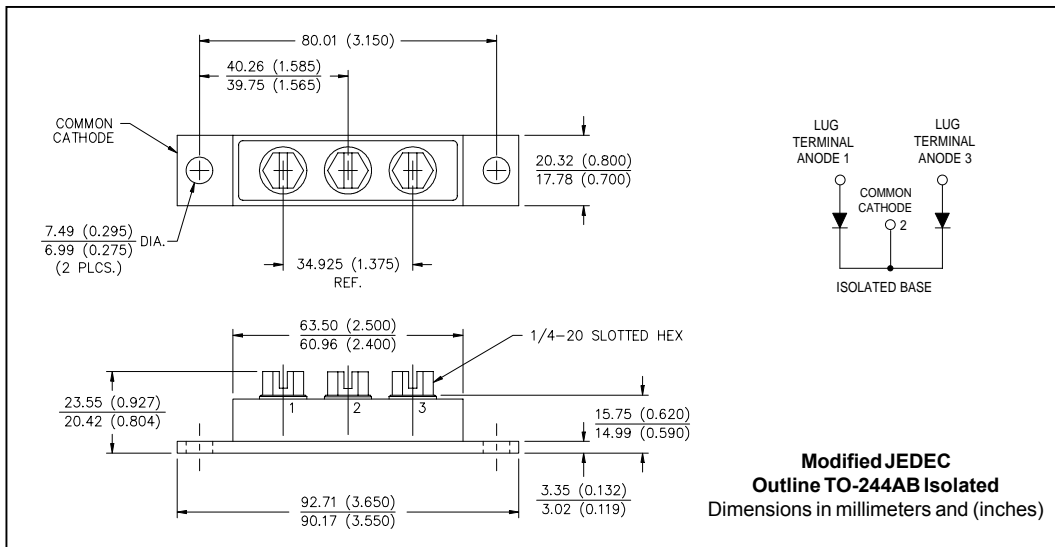

## 400CMQ... Series

Bulletin PD-20734 rev. B 08/01

International  
IR Rectifier

### Voltage Ratings

Part number	400CMQ035	400CMQ040	400CMQ045
$V_R$ Max. DC Reverse Voltage (V)	35	40	45
$V_{RWM}$ Max. Working Peak Reverse Voltage (V)			

### Absolute Maximum Ratings

Parameters	400CMQ	Units	Conditions
$I_{F(AV)}$ Max. Average Forward Current (Per Leg) * See Fig. 5 (Per Device)	200	A	50% duty cycle @ $T_C = 78^\circ\text{C}$ , rectangular waveform
	400		
$I_{FSM}$ Max. Peak One Cycle Non-Repetitive Surge Current (Per Leg) * See Fig. 7	29,000	A	5 $\mu\text{s}$ Sine or 3 $\mu\text{s}$ Rect. pulse 10ms Sine or 6ms Rect. pulse
	3400		
$E_{AS}$ Non-Repetitive Avalanche Energy (Per Leg)	180	mJ	$T_J = 25^\circ\text{C}$ , $I_{AS} = 40$ Amps, $L = 0.22$ mH
$I_{AR}$ Repetitive Avalanche Current (Per Leg)	40	A	Current decaying linearly to zero in 1 $\mu\text{sec}$ Frequency limited by $T_J$ max. $V_A = 1.5 \times V_R$ typical

### Electrical Specifications

Parameters	400CMQ	Units	Conditions
$V_{FM}$ Max. Forward Voltage Drop (Per Leg) * See Fig. 1 (1)	0.57	V	@ 200A
	0.73	V	@ 400A
	0.52	V	@ 200A
	0.68	V	@ 400A
$I_{RM}$ Max. Reverse Leakage Current (Per Leg) * See Fig. 2 (1)	20	mA	$T_J = 25^\circ\text{C}$
	800	mA	$T_J = 125^\circ\text{C}$
$V_{F(TO)}$ Threshold Voltage	0.32	V	$T_J = T_J$ max.
$r_f$ Forward Slope Resistance	0.81	m $\Omega$	
$C_T$ Max. Junction Capacitance (Per Leg)	10,300	pF	$V_R = 5V_{DC}$ , (test signal range 100Khz to 1Mhz) $25^\circ\text{C}$
$L_S$ Typical Series Inductance (Per Leg)	5.0	nH	From top of terminal hole to mounting plane
dv/dt Max. Voltage Rate of Change	10000	V/ $\mu\text{s}$	(Rated $V_R$ )
$V_{RMS}$ Insulation Voltage	1000	V	

### Thermal-Mechanical Specifications

(1) Pulse Width < 300 $\mu\text{s}$ , Duty Cycle < 2%

Parameters	400CMQ	Units	Conditions
$T_J$ Max. Junction Temperature Range	-55 to 150	$^\circ\text{C}$	
$T_{stg}$ Max. Storage Temperature Range	-55 to 150	$^\circ\text{C}$	
$R_{thJC}$ Max. Thermal Resistance Junction to Case (Per Leg)	0.4	$^\circ\text{C}/\text{W}$	DC operation * See Fig. 4
$R_{thJC}$ Max. Thermal Resistance Junction to Case (Per Package)	0.2	$^\circ\text{C}/\text{W}$	DC operation
$R_{thCS}$ Typical Thermal Resistance, Case to Heatsink	0.1	$^\circ\text{C}/\text{W}$	Mounting surface, smooth and greased
wt Approximate Weight	79(2.80)	g(oz.)	
T Mounting Torque	Min.	40(35)	Kg-cm (lbf-in)
		58(50)	
	Max.	17(15)	
		58(50)	
Terminal Torque	Min.	86(75)	
Case Style	TO-244AB isolated		Modified JEDEC

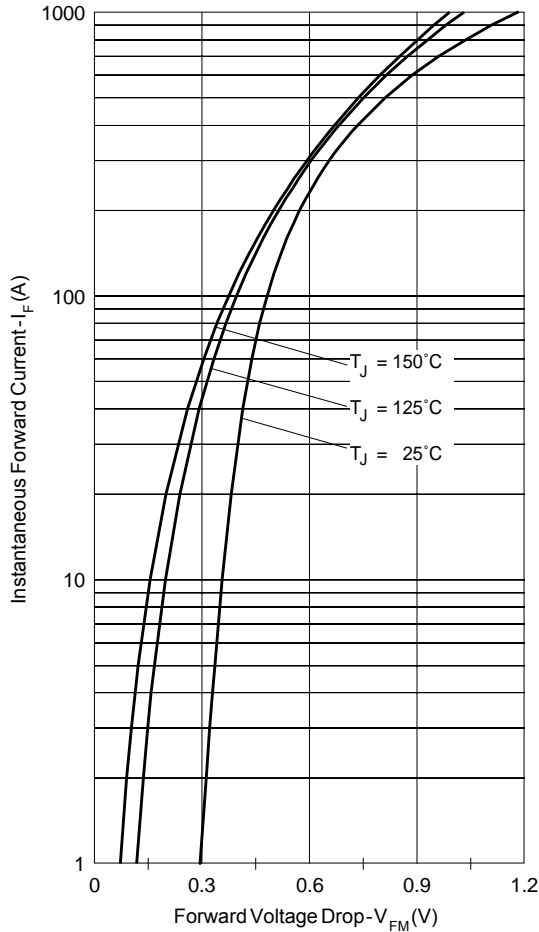

Fig. 1 - Max. Forward Voltage Drop Characteristics

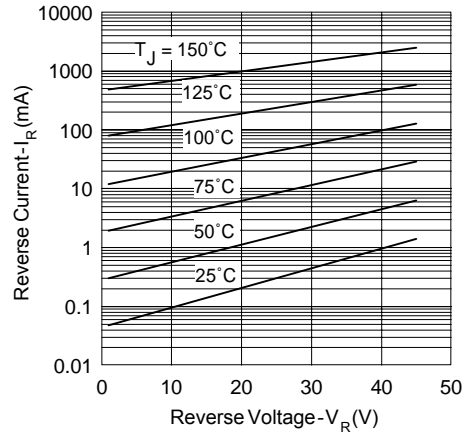

Fig. 2 - Typical Values Of Reverse Current Vs. Reverse Voltage

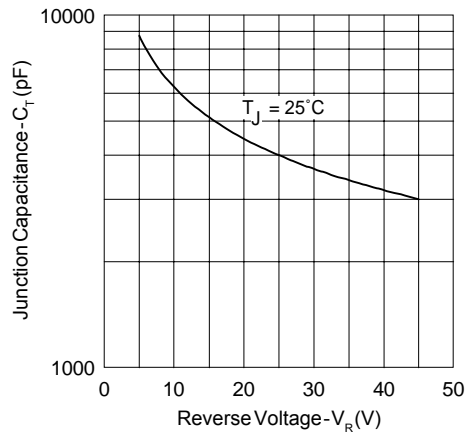

Fig. 3 - Typical Junction Capacitance Vs. Reverse Voltage

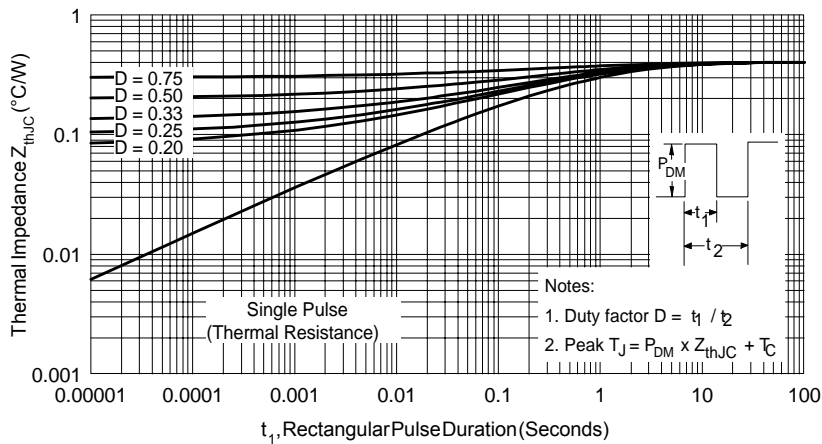

Fig. 4 - Max. Thermal Impedance  $Z_{thJC}$  Characteristics (Per Leg)

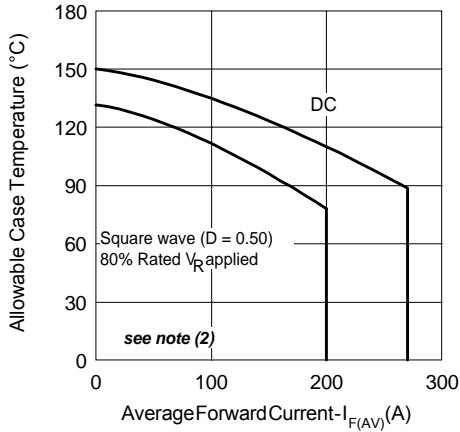

Fig. 5 - Max. Allowable Case Temperature Vs. Average Forward Current

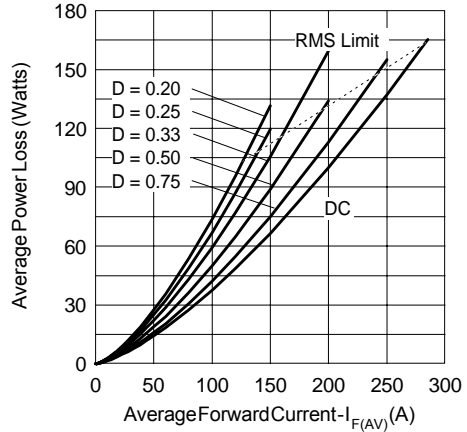

Fig. 6 - Forward Power Loss Characteristics

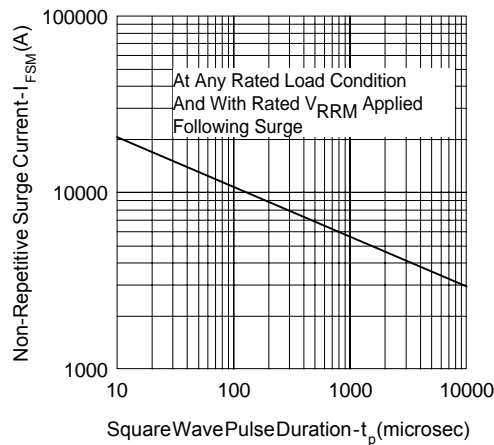

Fig. 7 - Max. Non-Repitative Surge Current

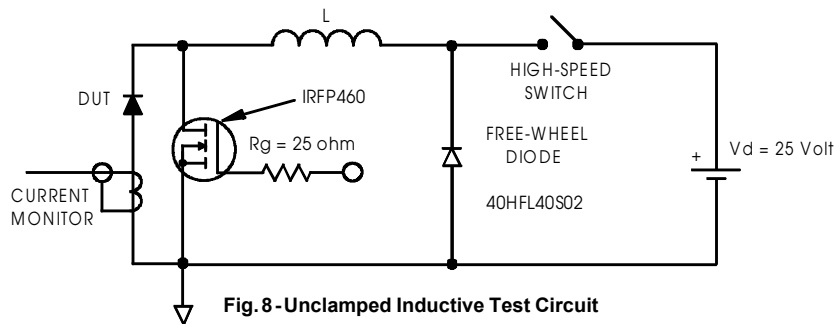
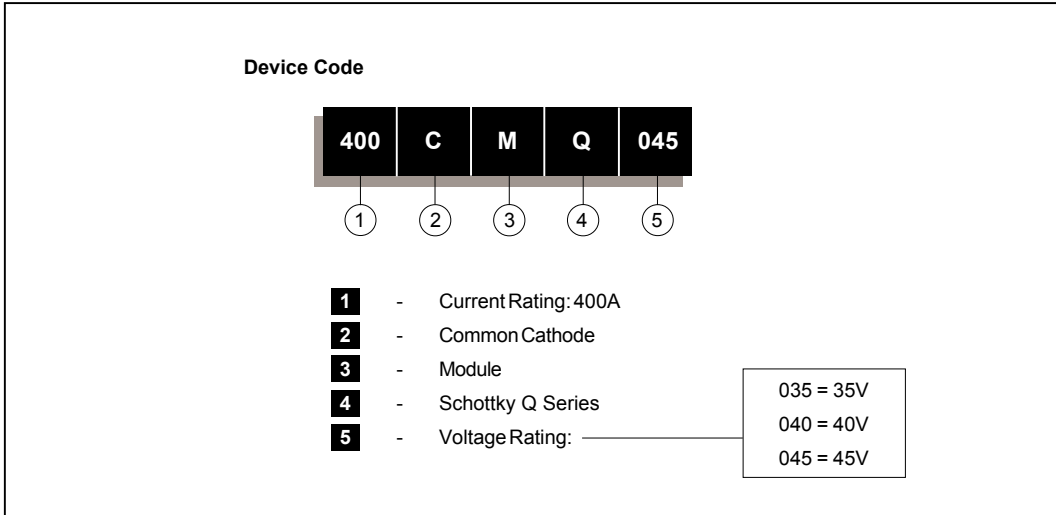

Fig. 8 - Unclamped Inductive Test Circuit

- (2) Formula used:  $T_C = T_J - (Pd + Pd_{REV}) \times R_{thJC}$ ;  
 $Pd = \text{Forward Power Loss} = I_{F(AV)} \times V_{FM} @ (I_{F(AV)} / D)$  (see Fig. 6);  
 $Pd_{REV} = \text{Inverse Power Loss} = V_{R1} \times I_R (1 - D)$ ;  $I_R @ V_{R1} = 80\% \text{ rated } V_R$

Ordering Information Table



Data and specifications subject to change without notice.  
 This product has been designed and qualified for Industrial Level.  
 Qualification Standards can be found on IR's Web site.